

BAR BENDING SHAPE CODES AS PER BS 8666

Table 1 – Standard shapes, their method of measurement and calculation of length

Shape code	Shape	Total length of bar (L) measured along centre line
00		A
11		$A + (B) - 1/2\pi - d$  Neither A nor B shall be less than A in Table 3
12		$A + (B) - 1/2\pi - d$  Neither A nor B shall be less than A in Table 3 nor less than (R + 6d)
13		$A + 0.57B + (C) - 1.57d$  Neither A nor C shall be less than A in Table 3 nor less than $(\frac{1}{2}B + 5d)$ B shall not be less than $2(r + d)$ See note 2
15		$A + (C)$  Neither A nor C shall be less than A in Table 3 See note 1
21		$A+B+(C)-r-2d$  Neither A nor C shall be less than A in Table 3
25		$A+B+(E)$  Neither A nor B shall be less than A in Table 3 If E is the critical dimension, schedule as 99 and specify A or B as the free dimension See note 1

Reference: BS8666

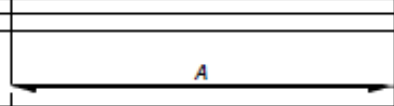
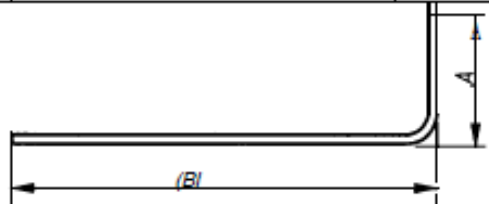
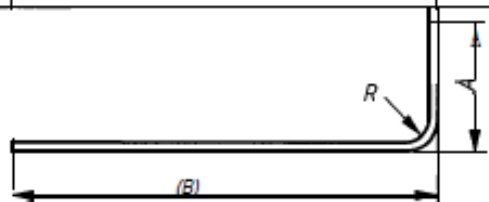
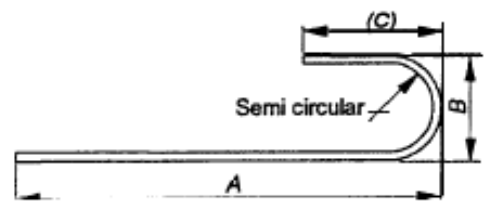
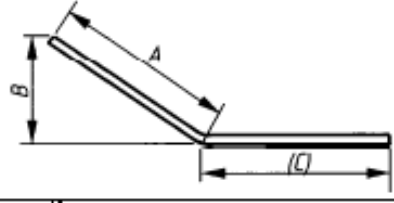
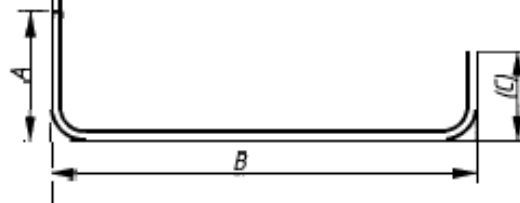
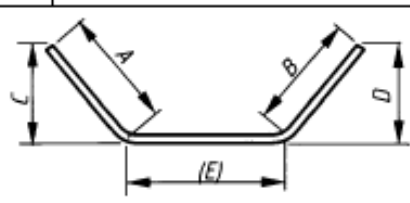

BAR BENDING SHAPE CODES AS PER BS 8666

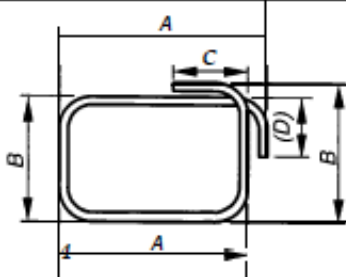
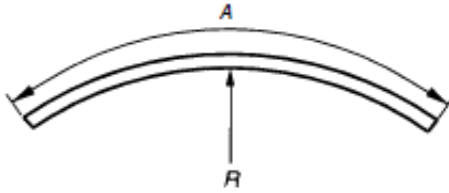

Table 1 – Standard shapes, their method of measurement and calculation of length (continued)

Shape code	Shape	Total length of bar (L) measured along centre line
26		$A+B+(C)$  Neither A nor C shall be less than A in Table 3 See note 1
31		$A+B+C+(D) - 1\frac{1}{2}r - 3d$  Neither A nor D shall be less than A in Table 3
33		$2A+3B+17d$  A shall not be less than $12d + 30\text{ mm}$ B shall not be less than $2(r + d)$  See note 2
41		$A+B+C+D+(E)-2r-4d$  Neither A nor E shall be less than A in Table 3
44		$A+B+C+D+(E)-2r-4d$  Neither A nor E shall be less than A in Table 3
46		$A+2B+C+(E)$  Neither A nor E shall be less than A in Table 3 See note 1



BAR BENDING SHAPE CODES AS PER BS 8666

Table 1 – Standard shapes, their method of measurement and calculation of length (continued)

Shape code	Shape	Total length of bar (L) measured along centre line
51		$2(A+B+C)-2\frac{1}{2}r-5d$  C and D shall be equal and not more than A or B nor less than A in Table 3
67		A  See clause 10
77	 <p>C= no. of turns</p>	$Cp(A - d)$  Where B is greater than A/5 this equation no longer applies and L shall be calculated
99	<p>All shapes where standard shapes cannot be used. No other shape code number, form of designation or abbreviation shall be used in scheduling. With the exception of rectangular links, 5 bends or more are undesirable and may be impractical within permitted tolerances but they shall be drawn out in full and coded 99.</p> <p>A dimensioned sketch shall be drawn over the dimension columns A to E. Every dimension shall be specified and the dimension that is to allow for permissible deviations shall be indicated in parenthesis, otherwise the fabricator is free to choose which dimension shall allow for the tolerance</p>	To be calculated
<p>For all shapes other than 12,13,33 and 67 the radius of bend shall be not less than the minimum specified in Table 3.</p> <p>The dimensions in parentheses are the free dimensions. If a shape given in this table is required but a different dimension is to allow for the possible deviations, the shape shall be drawn out and given the shape code 99 and the free dimension shall be indicated in parentheses.</p> <p>The length of straight between two bends shall be at least 4d, see Figure 6.</p> <p>NOTE 1 The length equations for shapes 15,25,26, and 46 are approximate and where the bend angle is greater than 48 the length should be calculated more accurately allowing for the difference between the specified overall dimensions and the true length measured along the central axis of the bar or wire. When the bending angles approach 90° it is preferable to specify shape code 99 with a fully dimensioned sketch.</p> <p>NOTE 2 For shapes with straight and semicircular lengths (e.g. shape codes 13 and 33) the largest practical radius for the production of a continuous curve is 200 mm, and for larger radii the curve may be produced by a series of straight sections.</p>		

Reference: BS8666



**BAR BENDING SHAPE CODES AS PER BS 8666**
**Table '2 – Standard fabric types and stock sheet size**

Fabric reference	Longitudinal wires			Cross wires			Mass kg/m <sup>2</sup>
	Nominal wire size mm	Pitch mm	Area mm <sup>2</sup> /m	Nominal wire size mm	Pitch mm	Area mm <sup>2</sup> /m	
Square mesh:							
A393	10	200	393	10	200	393	6.16
A252	8	200	252	8	200	252	3.95
A193	7	200	193	7	200	193	3.02
A142	6	200	142	6	200	142	2.22
A98	5	200	98	5	200	98	1.54
Structural mesh:							
B1131	12	100	1 131	8	200	252	10.9
B785	10	100	785	8	200	252	8.14
B503	8	100	503	8	200	252	5.93
B385	7	100	385	7	200	193	4.53
B283	6	100	283	7	200	193	3.73
B196	5	100	196	7	200	193	3.05
Long mesh:							
C785	10	100	785	6	400	70.8	6.72
C636	9	100	636	6	400	70.8	5.55
C503	8	100	503	5	400	49	4.34
C385	7	100	385	5	400	49	3.41
c283	6	100	283	5	400	49	2.61
Wrapping mesh:							
D98	5	200	98	5	200	98	1.54
D49	2.5	100	49	2.5	100	49	0.77
Tolerances shall be in accordance with Table 4. For standard fabric the type of wire shall be designated as a suffix to the fabric reference as illustrated in the example in Figure 3. Standard lengths and widths shall be 4.8 m and 2.4 m respectively, giving a sheet area of 11.52 m <sup>2</sup> .							



BAR BENDING SHAPE CODES AS PER BS 8666

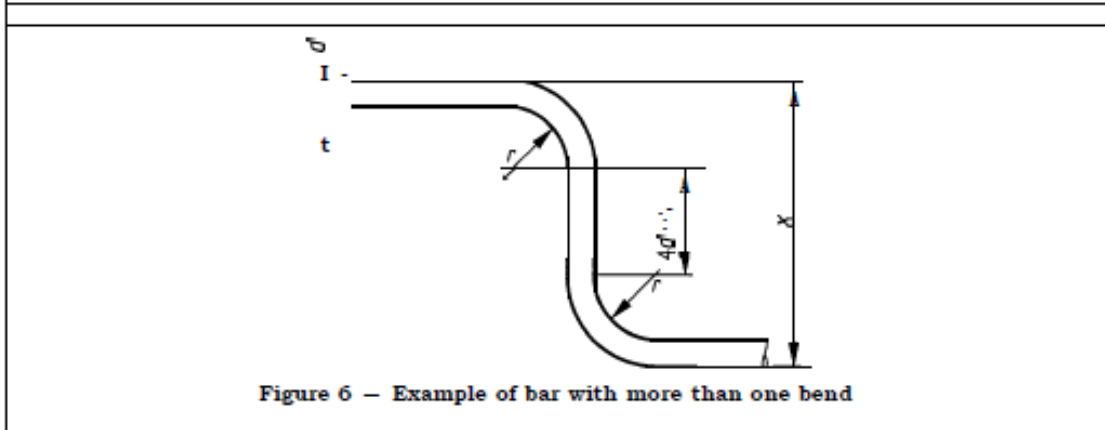
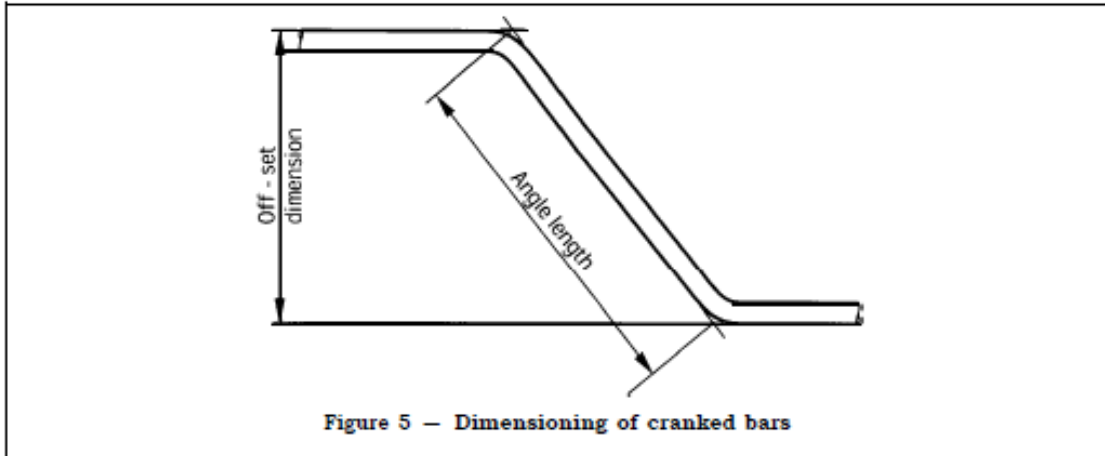

Reference: BS8666



**BAR BENDING SHAPE CODES AS PER BS 8666**

Table 3 – Minimum scheduling radius, former diameter and bend allowances

Dimensions in millimetres

Type and grade R				Type and grade T, B and S				Type and grade F, D and W			
Nominal size of bar	Minimum radius for scheduling	Minimum diameter of bending former	Minimum end dimension	Nominal size of bar	Minimum radius for scheduling	Minimum diameter of bending former	Minimum end dimension	Nominal size of wire	Minimum radius for scheduling	Minimum diameter of bending former	Minimum end dimension
<i>D</i>	<i>r</i>	<i>M</i>	<i>A</i>	<i>d</i>	<i>r</i>	<i>M</i>	<i>A</i>	<i>d</i>	<i>r</i>	<i>M</i>	<i>A</i>
—	—	—	—	—	—	—	—	5	10	20	110
6	12	24	110	6	12	24	110	6	12	24	110
—	—	—	—	—	—	—	—	7	14	28	115
8	16	32	115	8	16	32	115	8	16	32	115
—	—	—	—	—	—	—	—	9	18	36	120
10	20	40	120	10	20	40	120	10	20	40	120
12	24	48	125	12	24	48	125	12	24	48	125
16	32	64	130	16	32	64	130	—	—	—	—
20	40	80	160	20	70	140	190	—	—	—	—
25	50	100	200	25	87	175	240	—	—	—	—
32	64	128	260	32	112	224	305	—	—	—	—
40	80	160	320	40	140	280	380	—	—	—	—

NOTE 1 Due to "spring back" the actual radius of bend will be slightly greater than half the diameter of former.

NOTE 2 For bends (bobs) the minimum straight length beyond the end of the curved portion is 5*d*, or 10*d* for links.

Reference: BS8666



## BAR BENDING SHAPE CODES AS PER BS 8666

### 11 Bending of fabric reinforcement

NOTE The schedule for fabric reinforcement (see Figure 3) includes a column headed "bending instruction" for the additional information that is required when specifying bent fabric. The three-dimensional characteristic of fabric reinforcement can give rise to ambiguities that are best overcome by means of a simple sketch in the "bending instruction" column.

The sketch in the bending instruction column shall indicate the following:

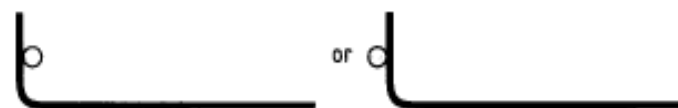

a) The direction of bending relative to the transverse wires

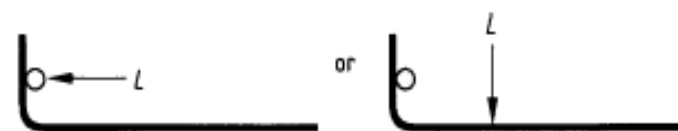

b) The direction of the longitudinal wires of the sheet to ensure bending about the correct axis

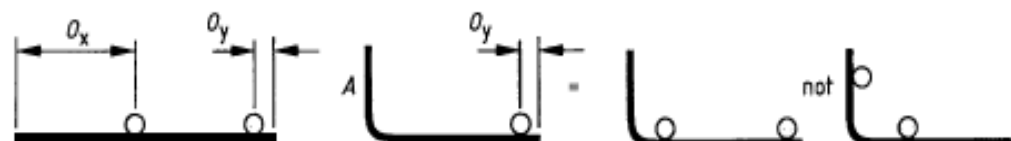

Sheet with unequal overhangs

c) The correct orientation of an asymmetric sheet to ensure the correct setting out of bending dimensions

For all bent fabric reinforcement, the bending dimensions shall avoid welded transverse wires occurring within four diameters of the start of a bend, see Figure 7.

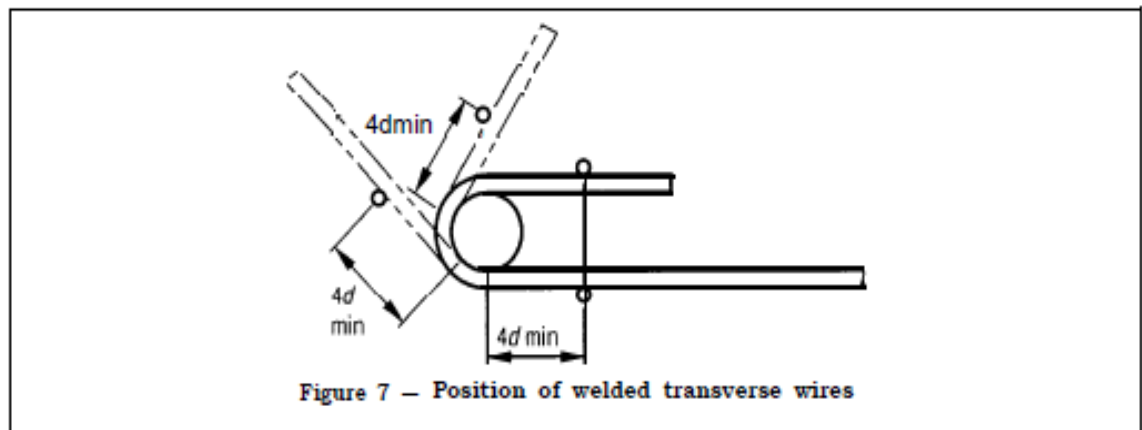

Figure 7 – Position of welded transverse wires

